

Series 392 and RV6/392M
0.5 Watt Thick-Film
Conductive-Plastic Potentiometer

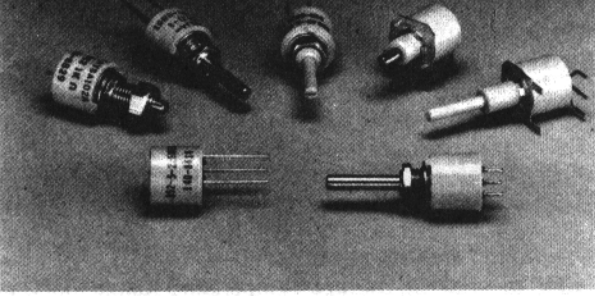

Series 392 Electrical Specifications

Resistance Range

100 Ω to 5 Megohms, linear; 500 Ω to 2 Megohms, tapered (commercial).
100 Ω to 1 Megohm, linear; 500 Ω to 1 Megohm, tapered (392M/RV6).

Resistance Tolerance

Linear, up to 1 Megohm $\pm 10\%$; 1 Megohm to 5 Megohms $\pm 20\%$.
Tapers, up to 250K Ω $\pm 10\%$; 250K Ω to 5 Megohms $\pm 20\%$.

Power Rating (Watts)

0.5 watt maximum continuous power rating for linear taper, but voltage not to exceed rating. Full rating @ 70°C, derated linearly to zero watts at 120°C. Derate all non-linear tapers by multiplying wattage rating by 0.5. See Chart B, page 52. Bushingless style derated to .25 watt.

Electrical Rotation

295° $\pm 5^\circ$

Effective Rotation

265°, +0°/-10°

Tapers

Right or left-hand available. See Chart A, page 51.

Taper Tolerance

$\pm 20\%$ of nominal resistance @ 50% $\pm 3\%$ mechanical rotation

End Resistance

4 Ω maximum for linear taper; 15 Ω maximum for non-linear tapers.

Dielectric Withstanding Voltage

750 Vac for 60 seconds @ ATM pressure.
350 Vac for 60 seconds @ 3.4 in. Hg.

Working Voltage

350 Vdc across end terminals, but power not to exceed rating.

Resistance Temperature Characteristics

See Chart C, page 52.

Dynamic Noise

Linear single controls maximum initial noise level 1.5% of total resistance. Measurement made using a constant current source and oscilloscope detection technique. 1% available on special order.

Linearity

$\pm 5\%$ independent linearity measured over 1% to 99% voltage ratio output.

Voltage Coefficient

.008%/Volt, maximum

Description

Our Series 392 and RV6/392M, are economical potentiometers designed to meet wave soldering applications for mounting to PC boards. They meet flow solderability and washability test requirements, and MIL-R-94 standards apply where appropriate.

Series 392M incorporates all the washable characteristics of the Series 392, the new military version Series 392M is now QPL listed under MIL-R-94 Style RV6. Turn to the stock options, page 56 for a complete listing of available types and stock values.

Features

- Washable and wave solderable
- Shaft seal standard
- Locking bushings available standard
- Low cost
- Made in accordance to MIL-R-94

Series 392 Mechanical Specifications

Mechanical Rotation

295° ±5°

Stop Torque

3 lb. in. minimum (metal shaft)

2 lb. in. minimum (plastic shaft)

Torque Range

.20 to 2.0 oz. in. Other torques available.

Bushing Lengths

Metal: .25 in. (6.35mm), .375 in. (9.53mm), and .5 in. (12.7mm).

Plastic: .25 in. (6.35mm) and .375 in. (9.53 mm).

Shafts, Standard

.125 in. (3.18mm) diameter

Shaft Lengths

Metal: Lengths from flush with trimmer bushing to 3 in. (76.2mm) in 1/64 in. (0.40 mm) increments. Brass, nickel-plated.

Plastic: Standard lengths of 3/8 in. (9.53mm), 1/2 in. (12.7mm), 5/8 in. (15.88mm), 3/4 in. (19.05mm), and 7/8 in. (22.23mm) Flat is .094 ±.002 x .250 in. (2.39mm ±0.051 x 6.35 mm) long. Slot is in line with contact and the flat is opposite the contact.

Switch

None available

Seal

O-ring shaft seal standard all styles, and the complete unit is sealed for wave solder and wash processing. The shaft seal withstands 5 PSI pressure. Mounting seals are available. See Chart D, page 52.

Housing

Thermoplastic polyester, blue (U.L. SE-O rating)

Hardware

Mounting hardware available. Hex mounted nut 1/4 in. (6.35mm) x 32 thread, 5/16 in. (7.94mm) across flats 1/16 in. (1.59mm) thick. Internal tooth lockwasher, 13.32 in. (10.32mm) outside diameter x .025 in. (.64mm) thick. Hex jam nut 5/16 in. (7.94mm) across flats 5/32 in. (3.97mm) thick.

Contact Material

Monel

Solvent Resistance

Housing resistant to trichlorethylene, *Chlorethene NU, **Freon TMS, Freon TMC, carbon tetrachloride, toluene, MEK, ethyl acetate and gasoline. For solvents not listed, contact Factory.

Mechanical Specifications continued

Terminals

Solder-coated. P.C. pin or solder hook style. PC pins fit .100 in. (2.54mm) grid spacing and .034 in. (0.86mm) diameter board holes. Pin diameter is .028 in. (0.71mm).

Weight (Aprox.)

Metal shaft & bushing .25 oz.; Plastic .1 oz.

*T.M. Dow Chemical Co.

**T.M. DuPont

Series 392 Operational Specifications

Operating Temperature Range

-40°C to +120°C.; Storage Temperature Range -55°C to +120°C.

Rotational Life

Rotational Life for linear control: 50,000 cycles, plain bushing style only. Change not to exceed 10% R (standard).

NOTE: SPECIFICATIONS SUBJECT TO CHANGE WITHOUT NOTICE.

Figure 1

Chart A

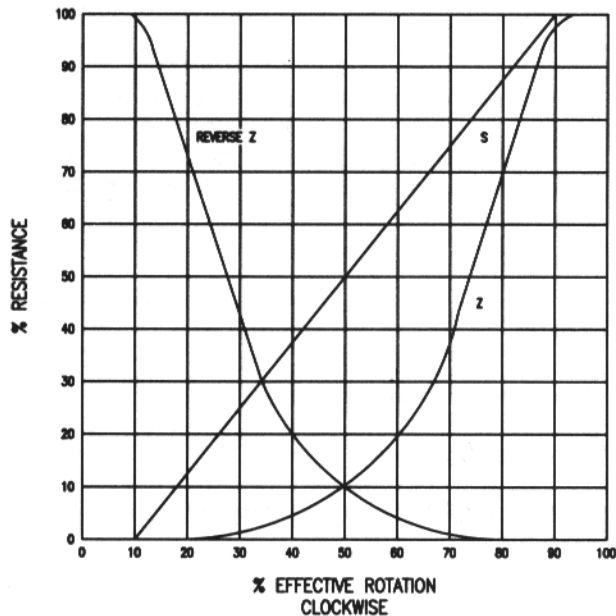

Curves Standard

The "S" taper is linear, the change in resistance value being directly proportional to the degree of rotation. It can be used either as right-hand or left-hand taper.

The "Z" taper attains 10% resistance value at 50% of clockwise rotation (left-hand).

The reverse "Z" taper attains 10% resistance value at 50% of counter-clockwise rotation (right-hand).

For conformity and special output curves, consult Factory.

Mechanical Specifications continued, next column

Figure 2
Chart B

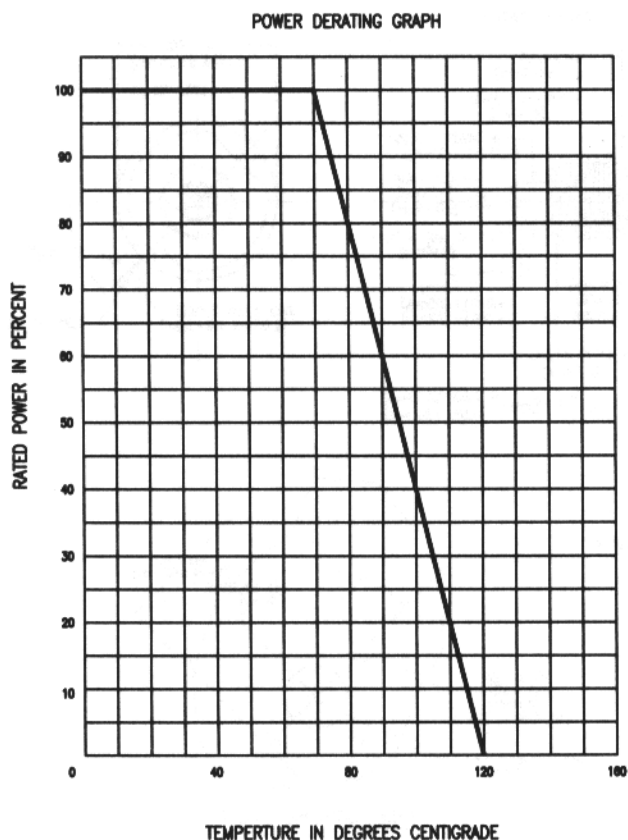
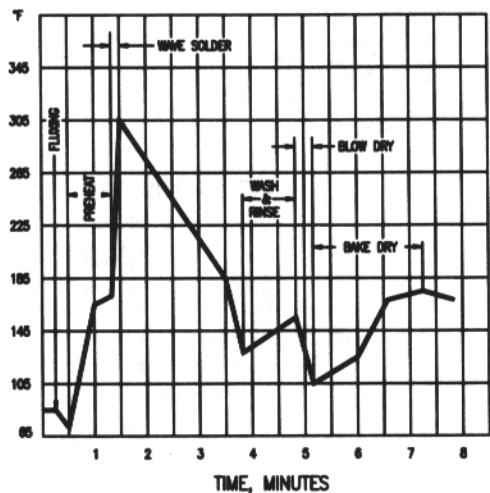

Figure 3
Chart C

NOMINAL RESISTANCE	MAXIMUM PERCENT TEMPORARY RESISTANCE FROM 25°C						
	-55°C	-40°C	0°C	+25°C	+55°C	+85°C	+120°C
100 OHMS	±5.0	±4.0	±1.5	0	±1.5	±2.0	±3.5
10K OHMS	+7.0	+5.5	+2.0	0	±1.5	±2.5	±5.5
100K OHMS	+8.0	+6.0	+2.5	0	±2.0	±3.5	±6.0
1 MEGOHMS	+10.0	+8.0	+3.0	0	±2.5	±4.0	±7.5

Figure 4
Chart D



**Wave Solder And Board Wash Parameters
Recommended Profile, Temperature on P.C. Board**

Process Limits	Temperature	Time
Preheat Maximum	195°F	1 minute
Solder Temperature Maximum	550°F	
Maximum differential temperature after solder in wash (3/4T)	72°F	
Wash Temperature	150-160°F	1 1/2 minutes
Dry Temperature	160-220°F	2 minute

Figure 5

Series 392 Potentiometer Dimensions

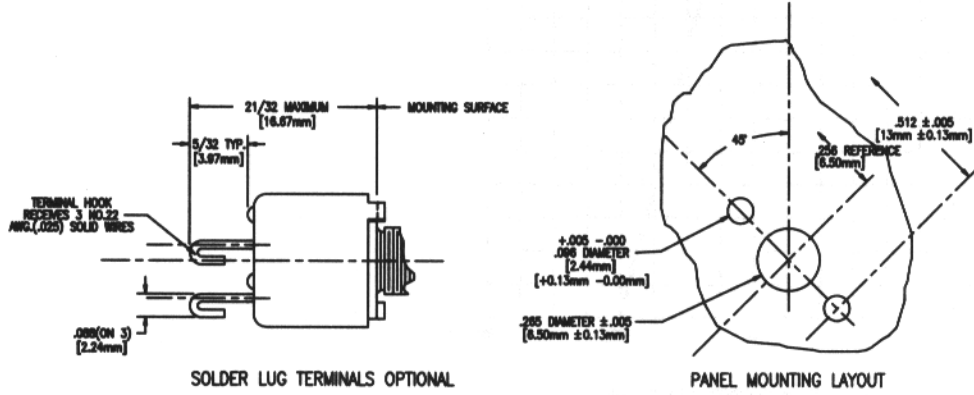
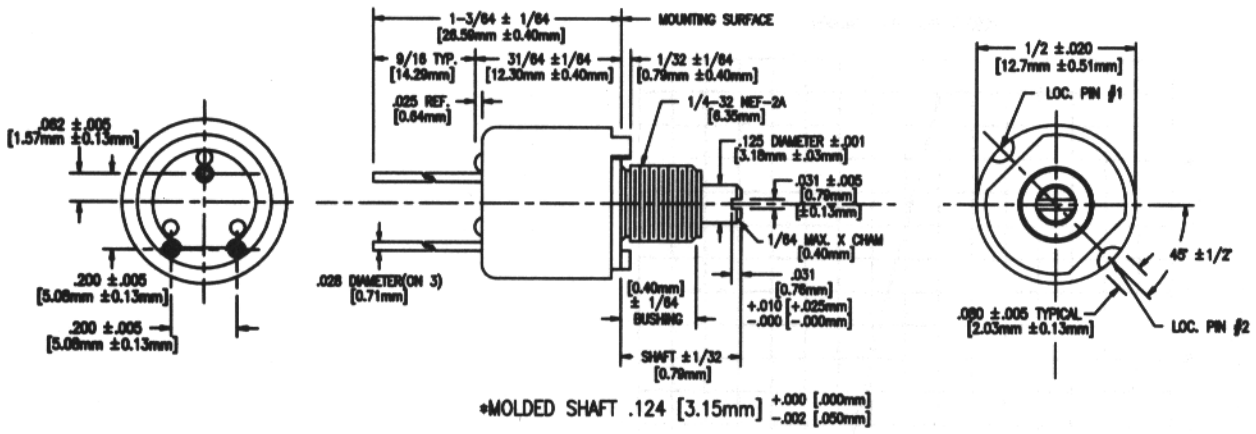

STOCK

BUSHING = $1/4$ " [6.35mm] LONG

SHAFT = $7/8$ " [22.23mm] LONG

Figure 6

Series 392-5 Trimmer Dimensions

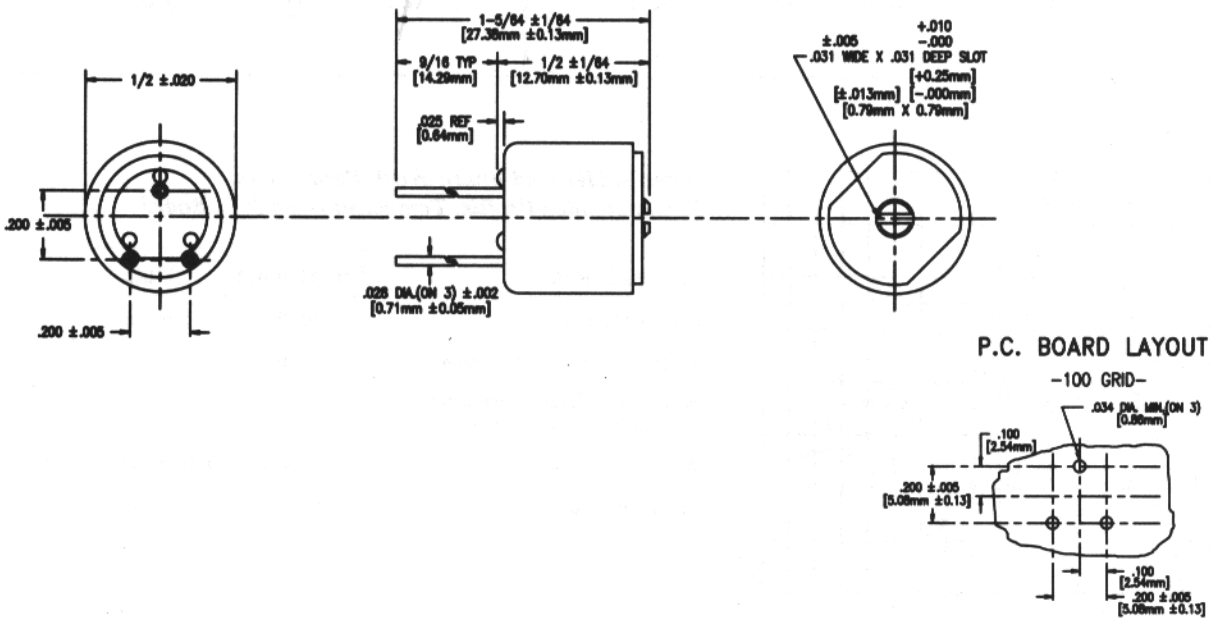

Figure 7

Series 392 B-56 Stud Mounting

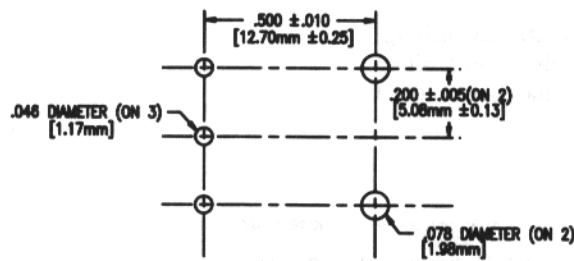
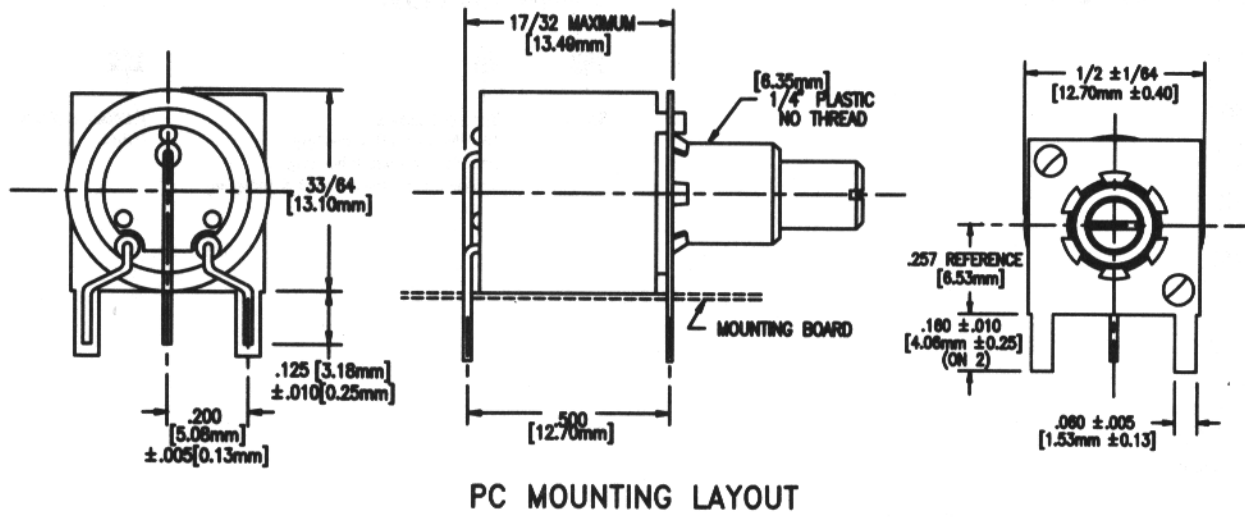
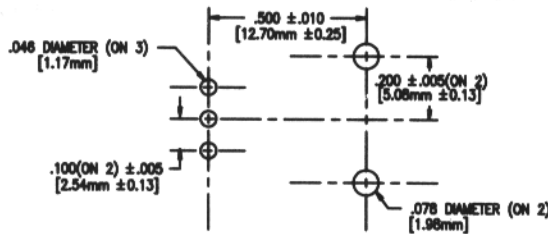
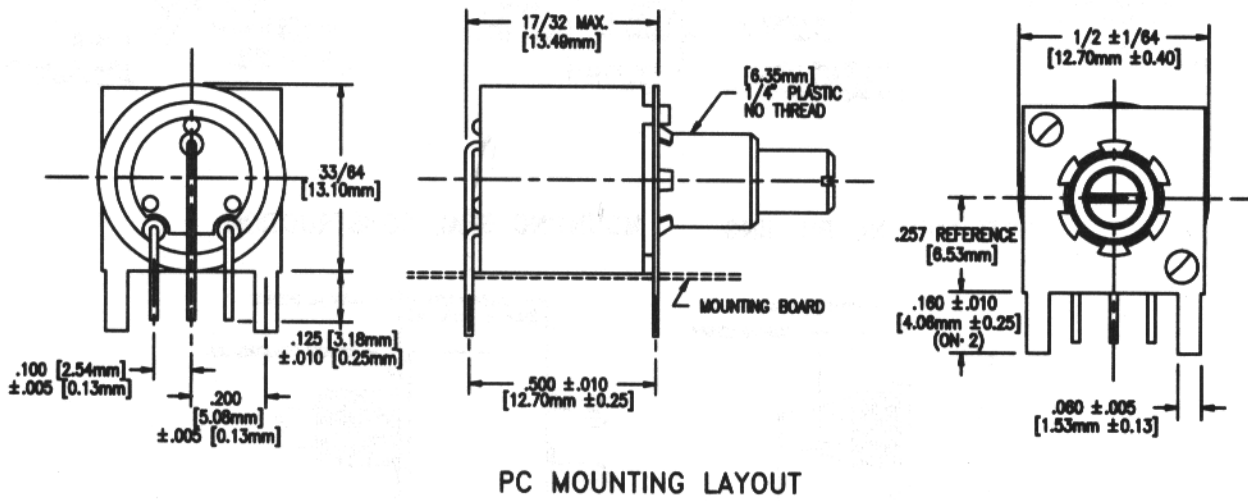

Figure 8

Series 392 B-57 Stud Mounting



Stock Values (Ohms)

- 100
- 250
- 500
- 1K
- 2500
- 5K
- 10K
- 25K
- 50K
- 100K
- 250K
- 500K
- 1 Meg.
- 2.5 Meg.
- 5 Meg.

Example: **392-JA-100**

392	JA	100
Series	Shaft & Bushing	Resistance Value
	JA = Metal shaft & bushing	(Ohms)
	JB = Plastic shaft & bushing	
	5 (Trimmer) = Plastic shaft & faceplate	

Catalog Number	Description
392JA	Metal shaft and bushing
392JB	Plastic shaft and bushing
392-5 Trimmer	Plastic shaft and faceplate

Figure 9
Series 392M/RV6 Dimensions

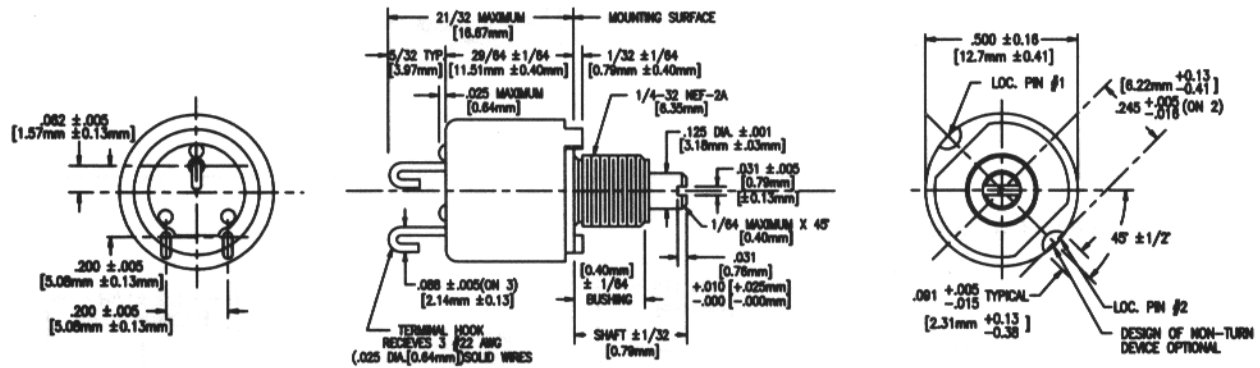

SPLIT LOCKING BUSHING

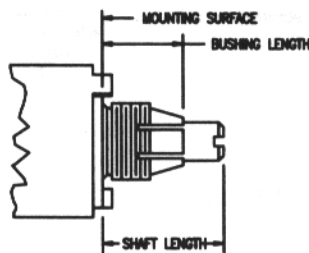

MOUNTING SEAL CONSTRUCTION

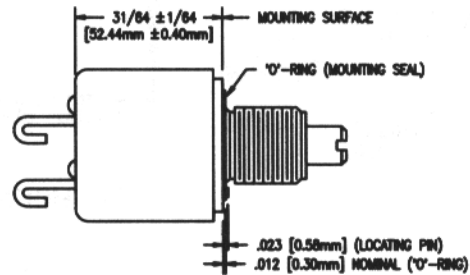

Series 392M/RV6 Standard Resistance Values

Stock Values (Ohms/Linear Taper)

<i>RV6NAY</i>		<i>RV6LAY</i>	
<i>SD</i>	<i>& SL</i>	<i>SA</i>	<i>& SD</i>
101A	252A	101A	252A
102A	253A	102A	253A
103A	254A	103A	254A
104A	501A	104A	501A
105A	502A	105A*	502A
153A	503A	153A	503A
154A	504A	154A*	504A
251A		251A*	205B*

Note: Special options available. Please consult Factory.
 *Made to order. Please consult Factory.

Series 392M/RV6 How To Order

Example: **RV6-N-A-Y-S-D-10-4-A-P**

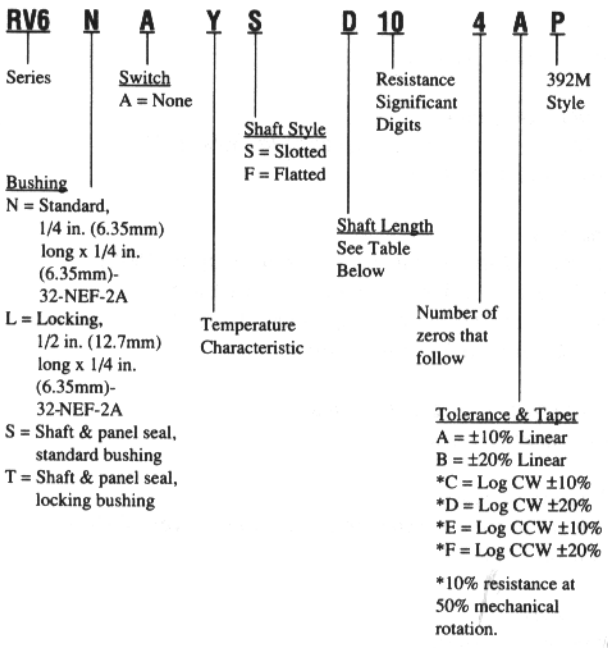

Shaft Length**

<i>Symbol</i>	<i>With 1/4 in. (6.35mm) Bushing N or S</i>	<i>With 1/2 in. (12.7mm) Bushing L or T</i>
A	5/8 in. (15.88mm)	5/8 in. (15.88mm)
B	1/2 in. (12.7mm)	-
D	7/8 in. (22.23mm)	7/8 in. (22.23mm)
L	3/8 in. (9.53mm)	-

**Shaft length from mounting surface.